



TECHNICAL SPECIFICATIONS

Pneumatic Forklift Trucks

D15S / D18S-5 & D20SC-5

G15S / G18S-5 & G20SC-5

1,500kg to 2,000kg Capacity

PRO5
SERIES



1,500/1,750/2,000 kg Capacities

Engine Powered Forklift Trucks

Pneumatic Tire

MAIN VEHICLE SPECIFICATIONS

				DOOSAN	DOOSAN	DOOSAN	DOOSAN	DOOSAN	DOOSAN	
CHARACTERISTICS	1	Manufacture		DOOSAN	DOOSAN	DOOSAN	DOOSAN	DOOSAN	DOOSAN	
	2	Model		D15S-5	D18S-5	D20SC-5	G15S-5	G18S-5	G20SC-5	
	3	Load Capacity	at rated load center	kg	1,500	1,750	2,000	1,500	1,750	2,000
	4	Load Center		mm	500	500	500	500	500	500
	5	Power type	Elec, Diesel, LPG, Gasoline		Diesel	Diesel	Diesel	LP	LP	LP
	6	Operator type			driver seated	driver seated	driver seated	driver seated	driver seated	driver seated
	7	Tire type	P:Pnu, E:Solid Soft, C: Cush		P	P	P	P	P	P
DIMENSIONS	8	Wheels (x=Driven)	Front/Rear		X 2 / 2	X 2 / 2	X 2 / 2	X 2 / 2	X 2 / 2	X 2 / 2
	9	Max. Fork Height	with STD 2-stage mast	mm	3,300	3,300	3,300	3,300	3,300	3,300
	10	Free Lift		mm	135	135	140	135	135	140
	12	Fork Carriage	ISO Class		II	II	II	II	II	II
	13	Forks	Length x Width x Thickness	mm	900x100x35	900x100x35	900x100x40	900x100x35	900x100x35	900x100x40
			Fork Spacing(Min x Max)	mm	240x905	240x905	240x905	240x905	240x905	240x905
	14	Tilt of Mast	Forward/Backward	deg	6 / 8	6 / 8	6 / 8	6 / 8	6 / 8	6 / 8
	15	Overall Dimensions	Length to Fork Face	mm	2,170	2,215	2,250	2,170	2,215	2,250
			Overall Width	mm	1,070	1,070	1,070	1,070	1,070	1,070
			Mast Lowered Height	mm	2,185	2,185	2,185	2,185	2,185	2,185
			Mast Extended Height	mm	4,355	4,355	4,360	4,355	4,355	4,360
			Overhead Guard Height	mm	2,170	2,170	2,170	2,170	2,170	2,170
	19	Seat Height		mm	1,005	1,005	1,005	1,005	1,005	1,005
21	Turning Radius	Minimum outside	mm	1,977	2,022	2,050	1,977	2,022	2,050	
22	Load Moment Center		mm	394	394	399	394	394	399	
23	Aisle 90 degree stacking(add load length & clearance)		mm	2,360	2,398	2,422	2,360	2,398	2,422	
PERFORMANCE	24	Travel Speed	Loaded/Unloaded	km/h	19 / 20	19 / 20	19 / 20	18 / 19	18 / 19	18 / 19
	25	Lifting Speed	Loaded/Unloaded	mm/s	600 / 630	600 / 630	600 / 630	600 / 650	600 / 650	600 / 650
	26	Lowering Speed	Loaded/Unloaded	mm/s	500 / 450	500 / 450	500 / 450	500 / 450	500 / 450	500 / 450
	28	Max. drawbar pull	Loaded at 1.0 mph (1.6km/h)	kg	1,400	1,400	1,400	1,440	1,430	1,420
	30	Max. gradeability	Loaded at 1.0 mph (1.6km/h)	%	32	30	29	35.5	31.0	28.5
	WEIGHT	32	Total Service Weight, Unloaded		kg	2,880	3,090	3,250	2,800	3,010
33		Axle Load	Loaded, Front/Rear	kg	3,800 / 580	4,165 / 677	4,545 / 705	3,775 / 525	4,140 / 620	4,520 / 650
			Unloaded, Front/Rear	kg	1,340 / 1,560	1,290 / 1,840	1,260 / 1,990	1,320 / 1,485	1,270 / 1,740	1,235 / 1,935
35		Number of wheels(F/R)			2 / 2	2 / 2	2 / 2	2 / 2	2 / 2	2 / 2
36	Tires	Size, Front		6.50x10-12	6.50x10-12	6.50x10-12	6.50x10-12	6.50x10-12	6.50x10-12	
		Size, Rear		5.00x8-10	5.00x8-10	5.00x8-10	5.00x8-10	5.00x8-10	5.00x8-10	
38	Wheel Base	Distance	mm	1,400	1,400	1,400	1,400	1,400	1,400	
39	Tread Width	Front/Rear	mm	890 / 910	890 / 910	890 / 910	890 / 910	890 / 910	890 / 910	
40	Ground Clearance	Loaded at the lowest point	mm	120	120	120	120	120	120	
		Loaded at center of wheelbase	mm	150	150	150	150	150	150	
42	Brakes	Service		Foot / Hyd	Foot / Hyd	Foot / Hyd	Foot / Hyd	Foot / Hyd	Foot / Hyd	
		Parking		Hand / Mech	Hand / Mech	Hand / Mech	Hand / Mech	Hand / Mech	Hand / Mech	
45	Battery	Volt/Ampere	V/AH	12 / 60	12 / 60	12 / 60	12 / 45	12 / 45	12 / 45	
POWER TRAIN	49	Engine	Manufacturer/Model		Kubota/V2403	Kubota/V2403	Kubota/V2403	HMC/G424I(E)	HMC/G424I(E)	HMC/G424I(E)
			Rated Power(DIN)	HP/rpm	45.8 / 2,400	45.8 / 2,400	45.8 / 2,400	45.5 / 2,450	45.5 / 2,450	45.5 / 2,450
				kW/rpm	34.2 / 2,400	34.2 / 2,400	34.2 / 2,400	33.9 / 2,450	33.9 / 2,450	33.9 / 2,450
			Maximum Torque	kg · m/rpm	15.9 / 1,600	15.9 / 1,600	15.9 / 1,600	15.1 / 1,600	15.1 / 1,600	15.1 / 1,600
	51		Cylinders/Displacements	cc	4 / 2,434	4 / 2,434	4 / 2,434	4 / 2,359	4 / 2,359	4 / 2,359
55	Transmission	Type		powershift	powershift	powershift	powershift	powershift	powershift	
		Number of Speed (Fwd/Rev)		1 / 1	1 / 1	1 / 1	1 / 1	1 / 1	1 / 1	
57	Hydraulic Pressure	System	bar	176	199	216	176	199	216	
		Attachment	bar	176	199	216	176	199	216	

Note: Specification values quoted in this specification sheet has been rounded. Performance may vary due to operation conditions.
Products and specifications are subject to improvement and change without prior notices.

MAST SPECIFICATIONS and RATED CAPACITIES

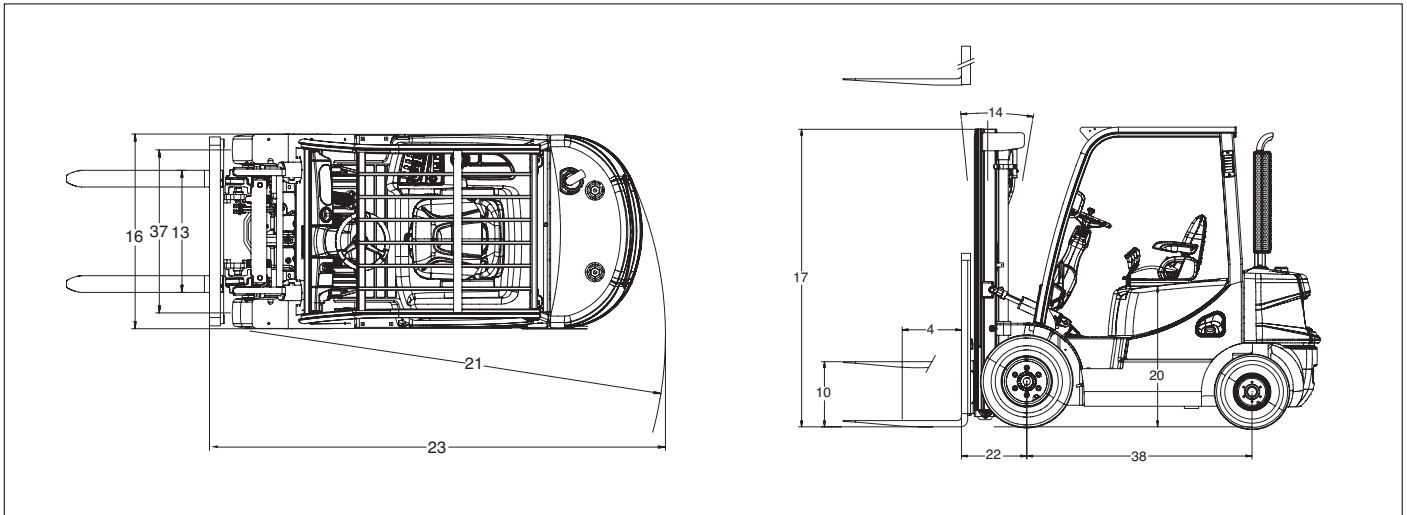

D/G15S-5

Mast type	Maximum Fork Height	Maximum Lowered Height	Fully Extended Height	Free Lift	Rated Load Capacities		
					D/G15S-5		
					Tilt Angle		Load Capacities
	mm	mm	mm	mm	FWD deg	BWD deg	LC 500mm kg
STD	3000	2035	4055	135	6	8	1500
	3300	2185	4355	135	6	8	1500
	3500	2285	4555	135	6	8	1500
	3700	2385	4755	135	6	8	1500
	4000	2585	5055	135	6	8	1500
FF	2700	1885	3755	880	6	8	1500
	3000	2035	4055	1030	6	8	1500
	3300	2185	4355	1180	6	8	1500
FFT	4000	1915	5055	910	6	8	1500
	4500	2080	5555	1075	6	8	1475
	4750	2165	5805	1160	6	8	1425
	5000	2280	6055	1275	6	5	1400
	5500	2515	6555	1510	6	5	1275
	6000	2680	7055	1675	6	5	975

D/G18S-5

Mast type	Maximum Fork Height	Maximum Lowered Height	Fully Extended Height	Free Lift	Rated Load Capacities		
					D/G18S-5		
					Tilt Angle		Load Capacities
	mm	mm	mm	mm	FWD deg	BWD deg	LC 500mm kg
STD	3000	2035	4055	135	6	8	1750
	3300	2185	4355	135	6	8	1750
	3500	2285	4555	135	6	8	1750
	3700	2385	4755	135	6	8	1750
	4000	2585	5055	135	6	8	1750
FF	2700	1885	3755	880	6	8	1750
	3000	2035	4055	1030	6	8	1750
	3300	2185	4355	1180	6	8	1750
FFT	4000	1915	5055	910	6	8	1750
	4500	2080	5555	1075	6	8	1750
	4750	2165	5805	1160	6	8	1500
	5000	2280	6055	1275	6	5	1575
	5500	2515	6555	1510	6	5	1200
	6000	2680	7055	1675	6	5	900

D/G20SC-5

Mast type	Maximum Fork Height	Maximum Lowered Height	Fully Extended Height	Free Lift	Rated Load Capacities		
					D/G20SC-5		
					Tilt Angle		Load Capacities
	mm	mm	mm	mm	FWD deg	BWD deg	LC 500mm kg
STD	3000	2035	4060	140	6	8	2000
	3300	2185	4360	140	6	8	2000
	3500	2285	4560	140	6	8	2000
	3700	2385	4760	140	6	8	2000
	4000	2585	5060	140	6	8	2000
FF	2700	1885	3760	880	6	8	2000
	3000	2035	4060	1030	6	8	2000
	3300	2185	4360	1180	6	8	2000
FFT	4000	1915	5060	910	6	8	2000
	4500	2080	5560	1075	6	8	1700
	4750	2165	5810	1160	6	5	1750
	5000	2280	6060	1275	6	5	1525
	5500	2515	6560	1510	6	5	1150
	6000	2680	7060	1675	6	5	850



PRO5 SERIES



G15S / G18S-5 & G20SC-5
1,500kg 1,750kg 2,000kg
LP, Pneumatic Tire



D15S / D18S-5 & D20SC-5
1,500kg 1,750kg 2,000kg
Diesel, Pneumatic Tire

PSC0911B2 (Apr.2011)



Head Office : 7-11, Hwasu-Dong, Dong-Gu, Incheon, Korea.
Seoul Office : 22nd floor, Doosan Tower Bldg, Euljiro 6-Ga
Jung-Gu, Seoul, Korea.
Tel : 82-2-3398-8633 Fax : 82-2-3398-8619

AUTHORIZED DEALER

Product and specifications are subject to improvement and change without notice.